

A Wafer-Based, 3-D Metal Micro- Manufacturing Technology for Ultraminiaturized Medical Devices

IEEE EMBS

October 2008



What is EFAB Technology?

- Unique, ultra-precision freeform metal manufacturing technology
- Multi-layer process builds unlimited variety of complex, micro to millimeter scale devices, subsystems, and components

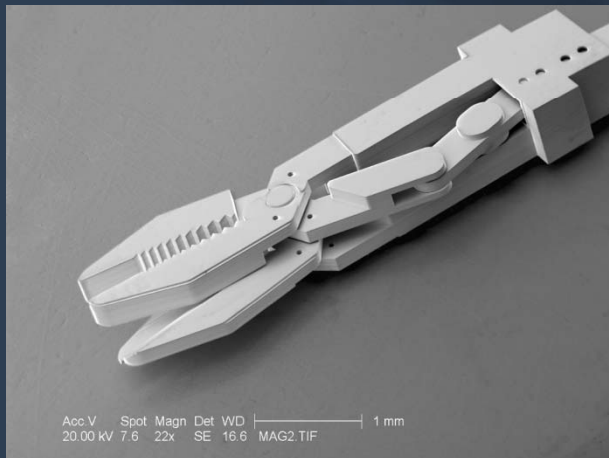

Multi-function endoscopic tool

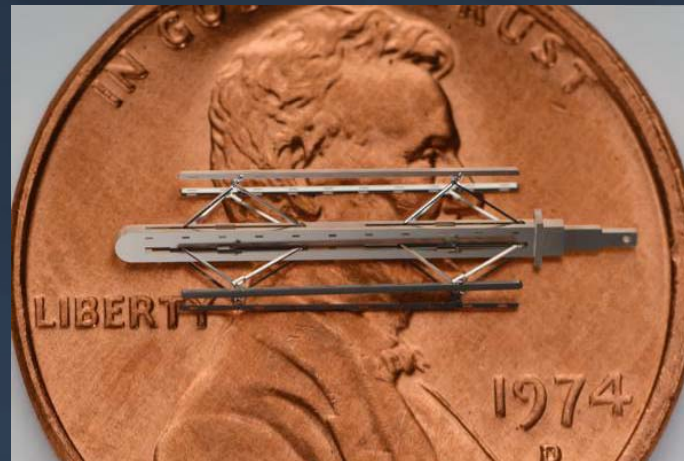

4-direction expander

EFAB Technology

- Creates dynamic, intricate, 3-D metal devices with flexibility & robustness unheard of in the MEMS world – no assembly required
- Real-world, mm-to-cm scale devices with micron precision features
- Enables a large variety of miniaturized mechanical & electrical systems otherwise impossible or impractical to build
- One-of-a-kind, heavily patented process
(>200 patents/applications)

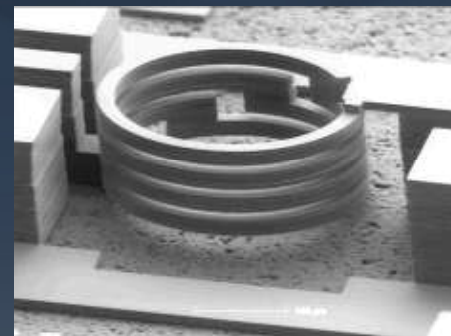
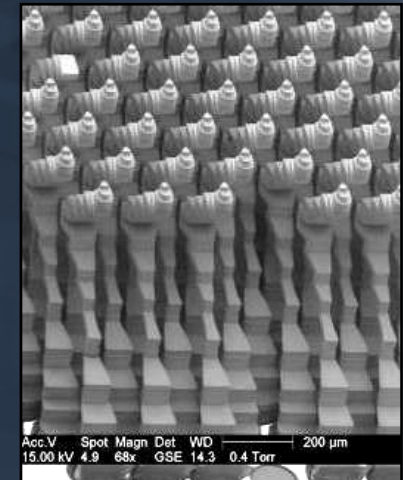
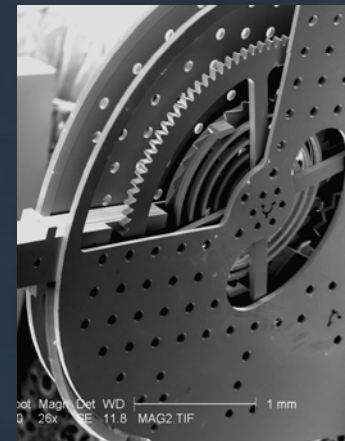

EFAB Devices

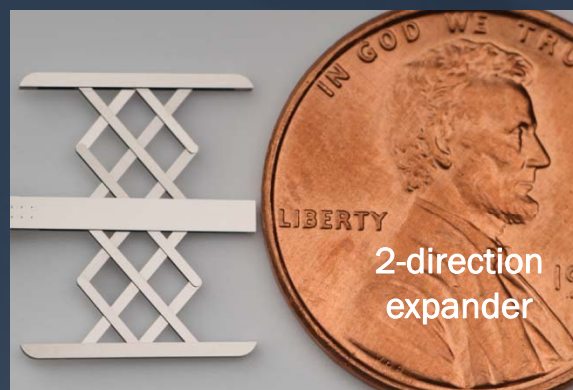
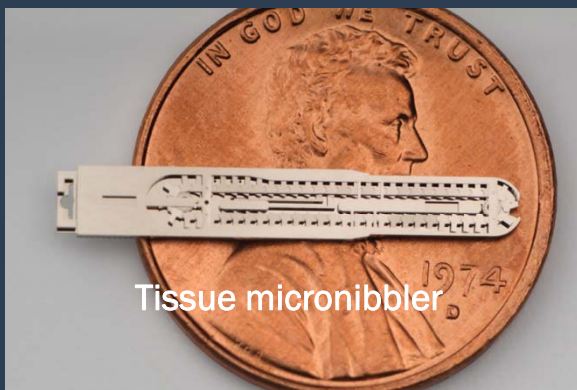
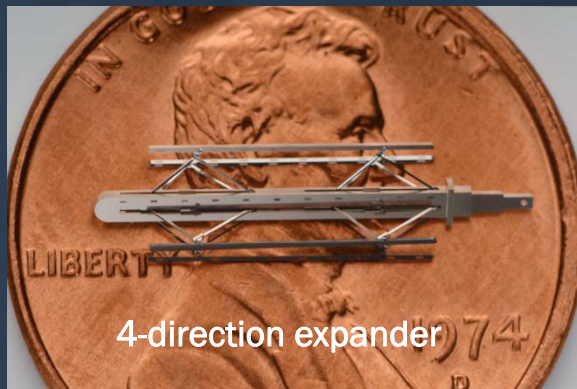
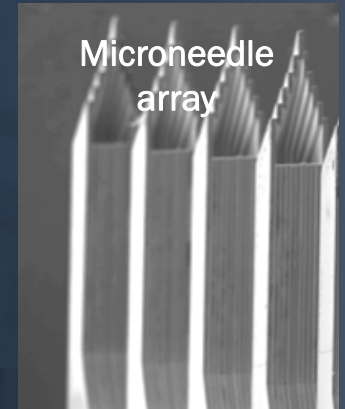

The EFAB Process

- EFAB is an additive/subtractive process performed in a cleanroom
- Devices are “grown” layer-by-layer on a wafer from at least two metals:
 - One is structural, one is sacrificial

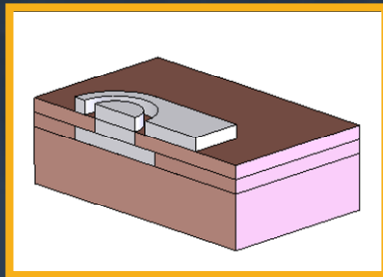

Step 1 – Pattern deposit structural metal

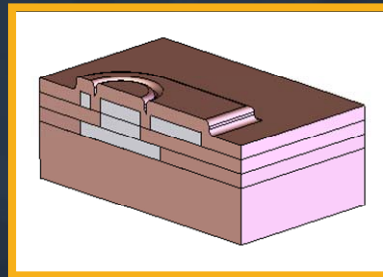

Step 2 - Blanket deposit sacrificial metal

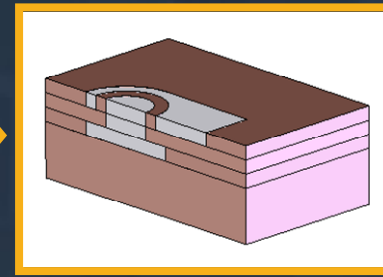

Step 3 -Planarize

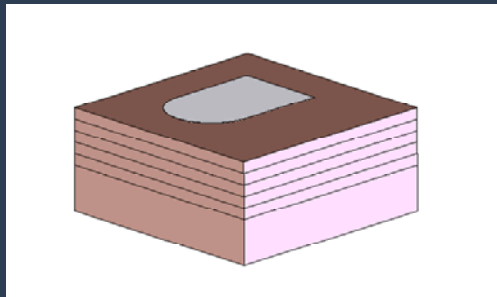

Device before release

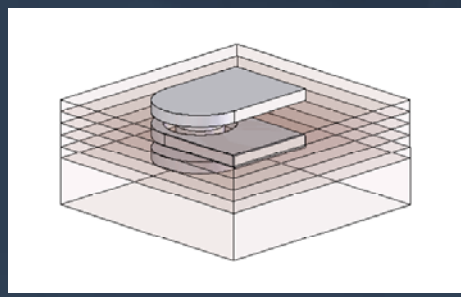

Device with sacrificial metal transparent

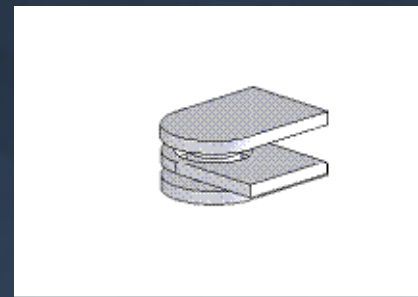

Finished device after etching away sacrificial metal

EFAB Process Flow



What's Really Unique About EFAB?

- Applies the paradigm of computer chip fabrication to metal part fabrication
- Can directly produce complex mechanisms with multiple moving parts without the need for assembly
- Complexity is nearly free
- Smaller is cheaper
- Large numbers of devices are produced simultaneously in a batch

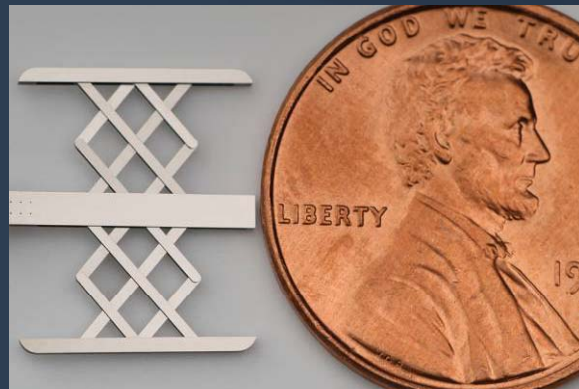

2-direction expander

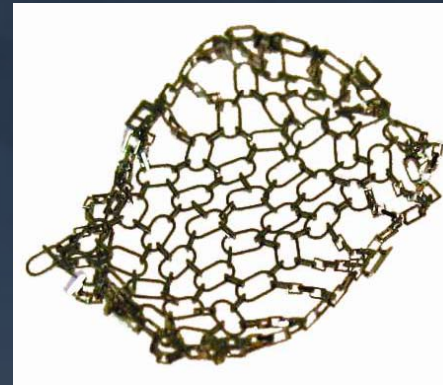

Chainmail basket

Additional EFAB Benefits

- Intricate free-form shapes, including internal features
- Features smaller than 0.0002”
- 0.0001” accuracy and repeatability
- Unlimited variety of products made by a single, well-characterized, well-controlled, process
 - Individual layers are formed the same way no matter what is being made
- The same process is used for prototyping and volume production
- Net shape fabrication, without burrs or artifacts: ready to use
- Reduced time-to-market
 - Multiple design variations produced simultaneously
 - Scale from prototype to low-cost volume production in just weeks



2-piece surgical clip with applicator



2-French/22-23 gauge forceps

Medical device example

Biopsy Forceps, 2 & 3 French (0.7 & 1 mm)

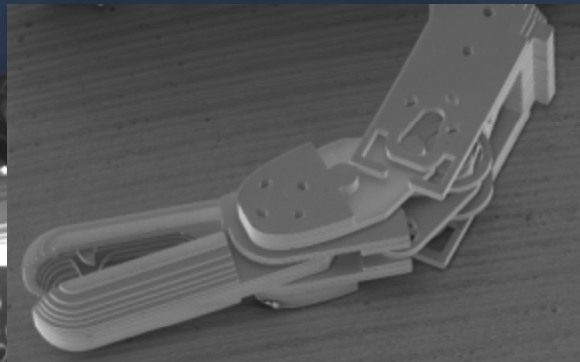

EFAB-Produced
Biopsy Forceps
(~ 1 mm width)

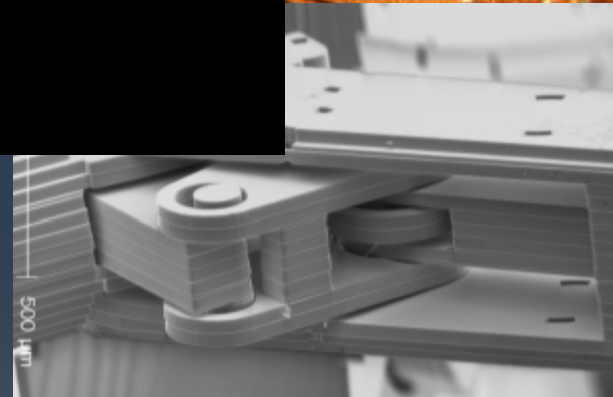
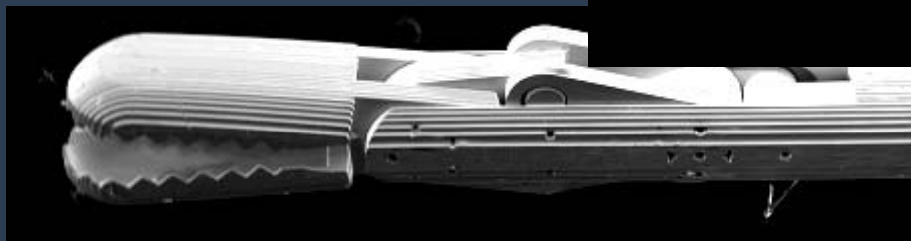

Medical device example

“MicroNibbler” Tissue Removal Device

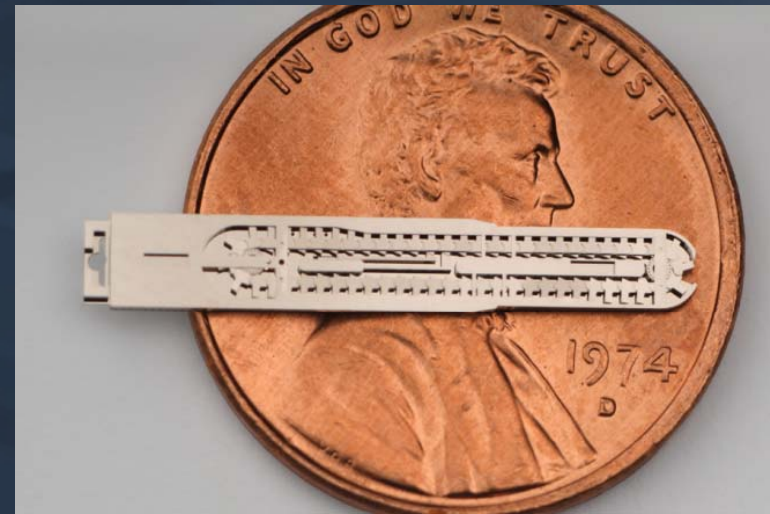
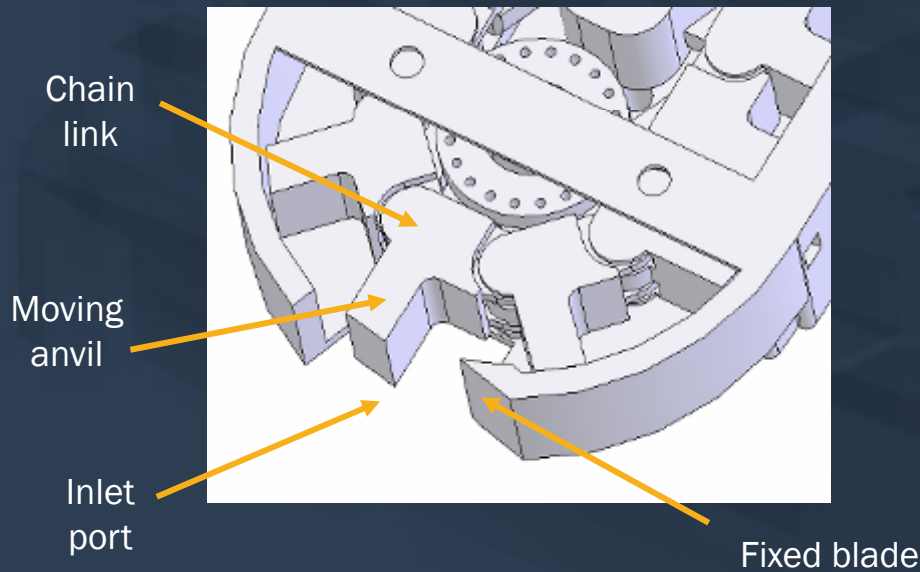

EFAB-Produced
MicroNibbler
(~ 3 mm width)

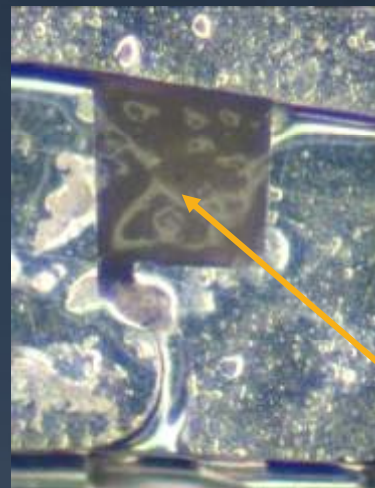

Medical device example

Internally-Barbed Biopsy Device

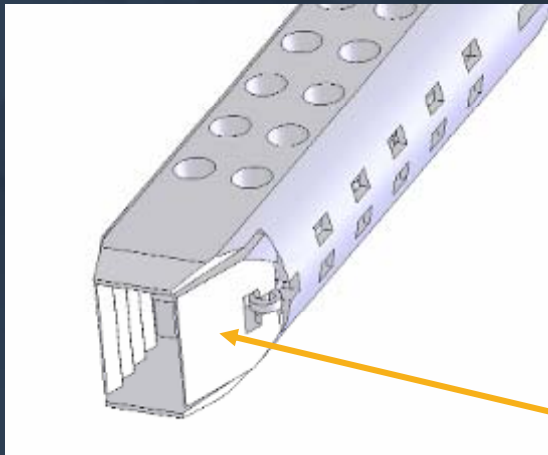

Internally-barbed jaw



Biopsy device (with ballpoint pen)

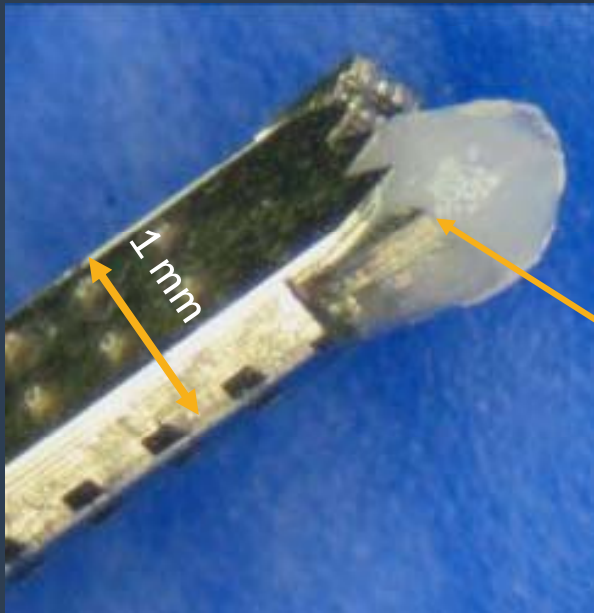

Captured tissue

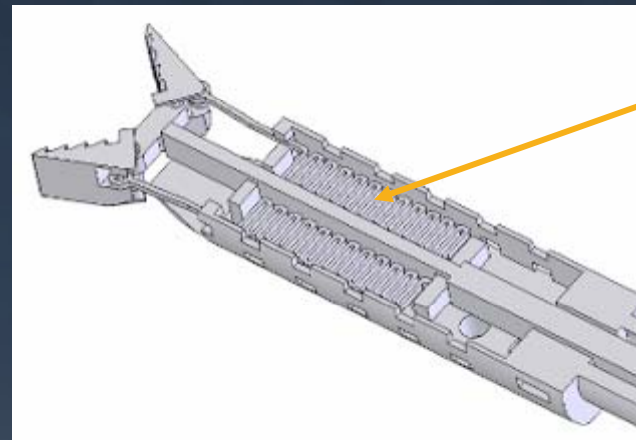

Internal spring

Medical device example

Hydraulic Forceps

- Saline-operated single-acting hydraulic forceps
- Hydraulic actuation
 - Allows use in tortuous anatomy
 - Offers precise force control and force feedback

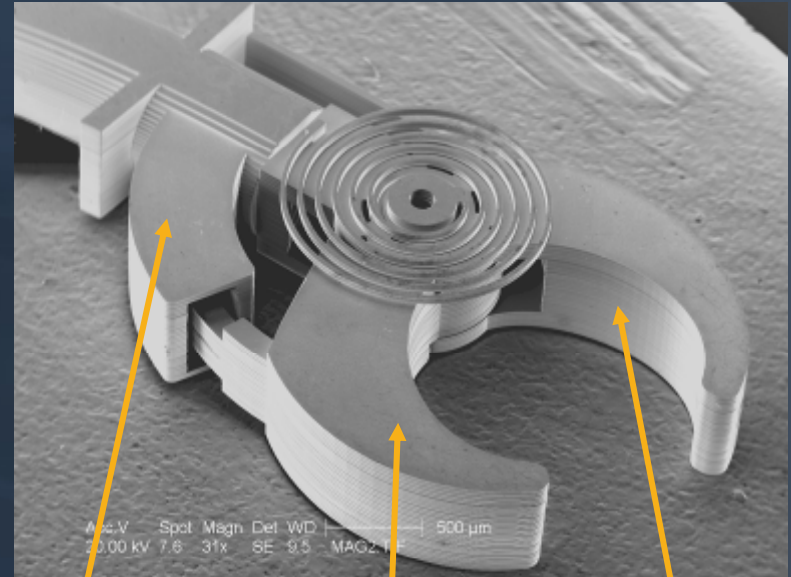

Curved cylinder with internal piston

Moving jaw

Fixed jaw



Hydraulic forceps (with ballpoint pen)

EFAB-Produced
Hydraulic Forceps
(~ 5 mm length)

Medical device example

“SplitClip” Tissue Approximation Device

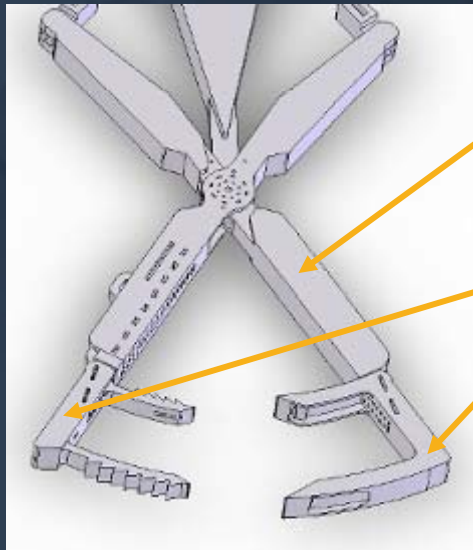

Clip applicator

Detachable clip halves



SplitClip (with applicator and ballpoint pen)



SplitClip delivered into tissue



Medical device example

Guidewire Distal Ends: Anchorable, Stiffenable, Steerable

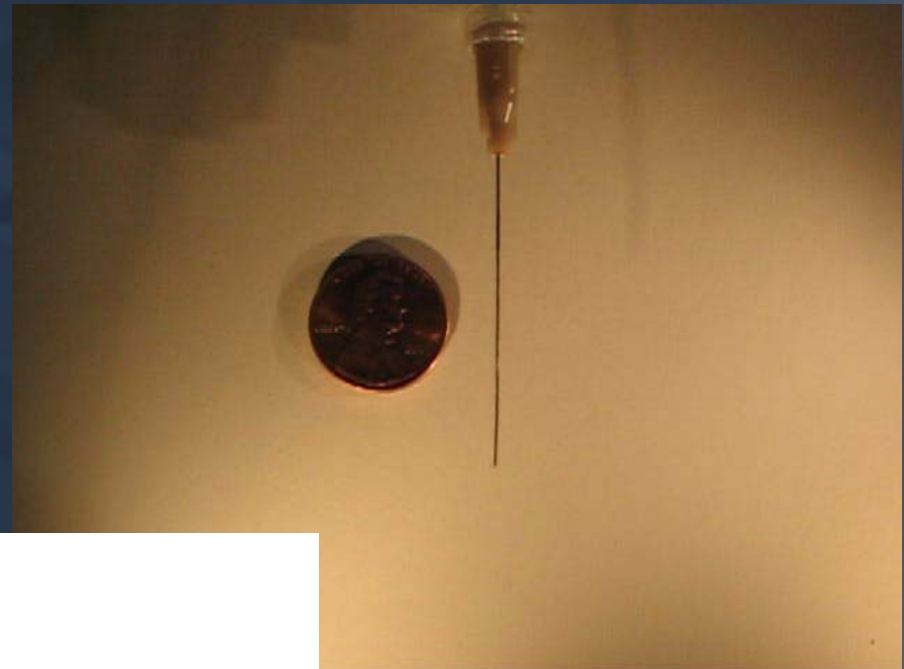
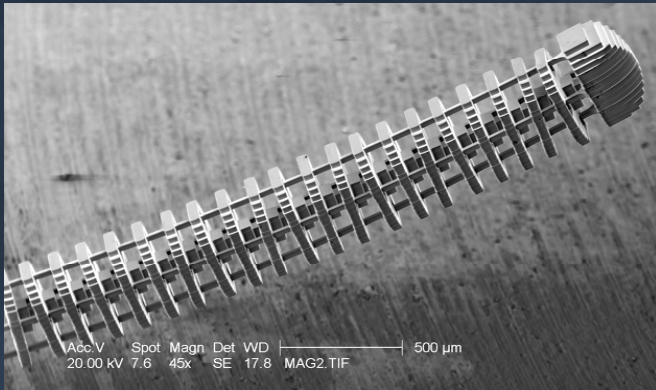

Medical device example

Precision Components

Examples of how EFAB can be used for “non-assembled” devices and components that require miniaturization and tight tolerances

- Multi-lumen metal structures
- Chain mail
- Micro “donuts” 254 μm in diameter and 200 μm tall built in a containment cage

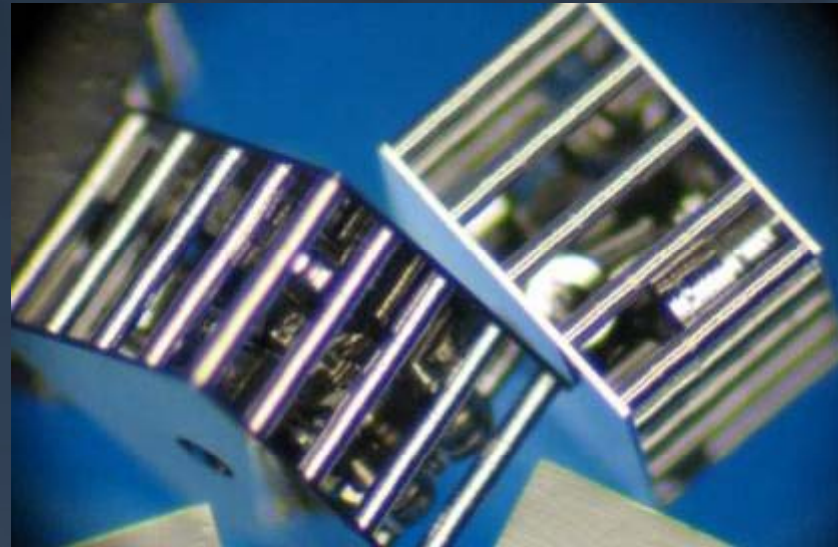
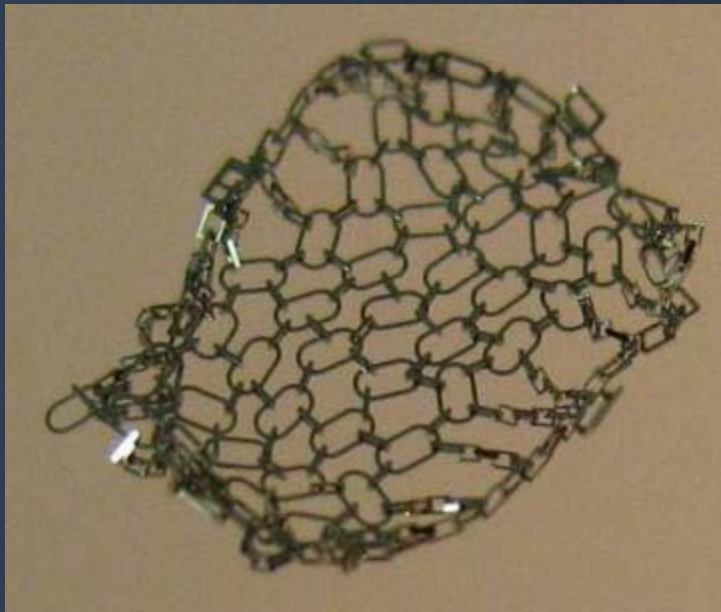
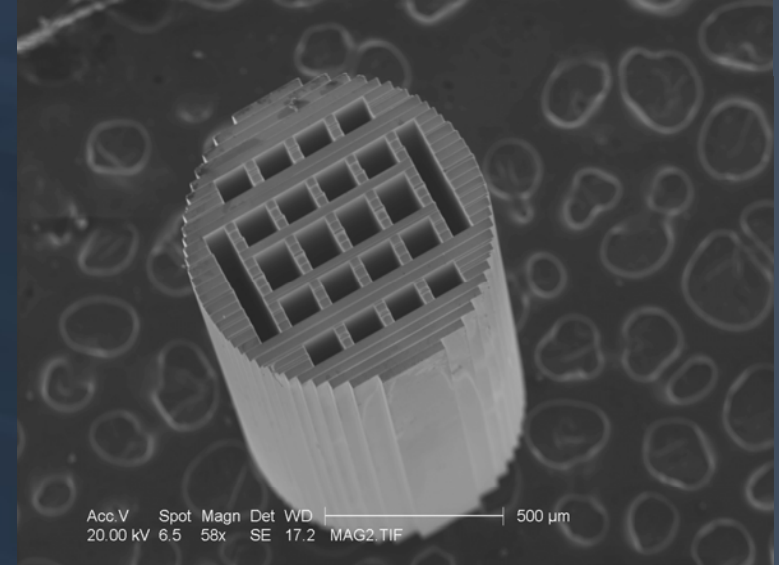

Example of capabilities

Hydraulic/Pneumatic Turbine

- Distal actuation for extremely small (0.9-1.2 mm diameter) and robust rotating devices
 - Cutting blade shown, other end-effectors may be used
- Not dependent on a stiff drive cable for rotation at high speeds
- Very hard metals (e.g., rhodium, a current EFAB material) can be used for wear resistance
- 1st prototypes built operated successfully: 120,000 RPM with flow rates ~ 10 ml/min

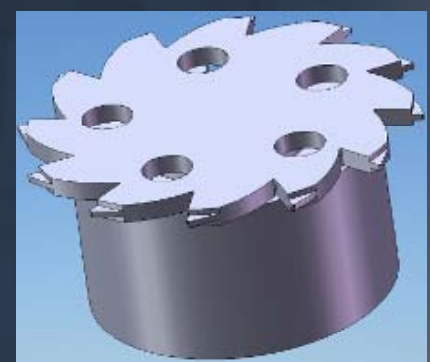
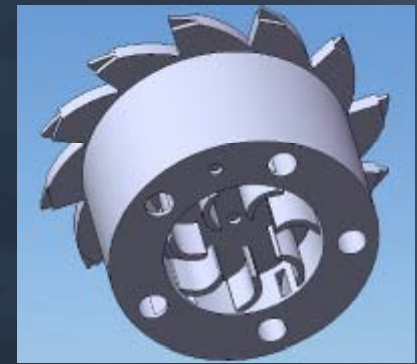
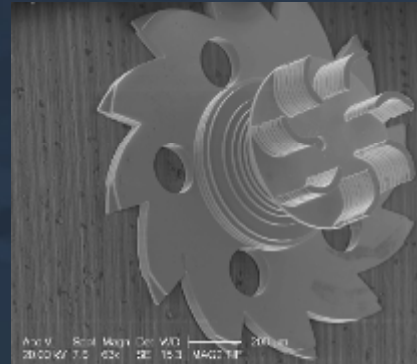

1.2-mm diameter turbine with blade

Example of capabilities “Expander”

- Expands from ~3 to ~16 mm when actuated by cable
- 2 or 4-direction expansion

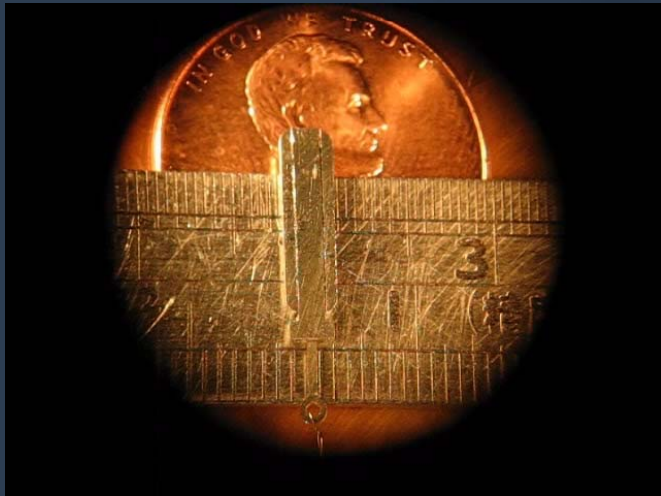
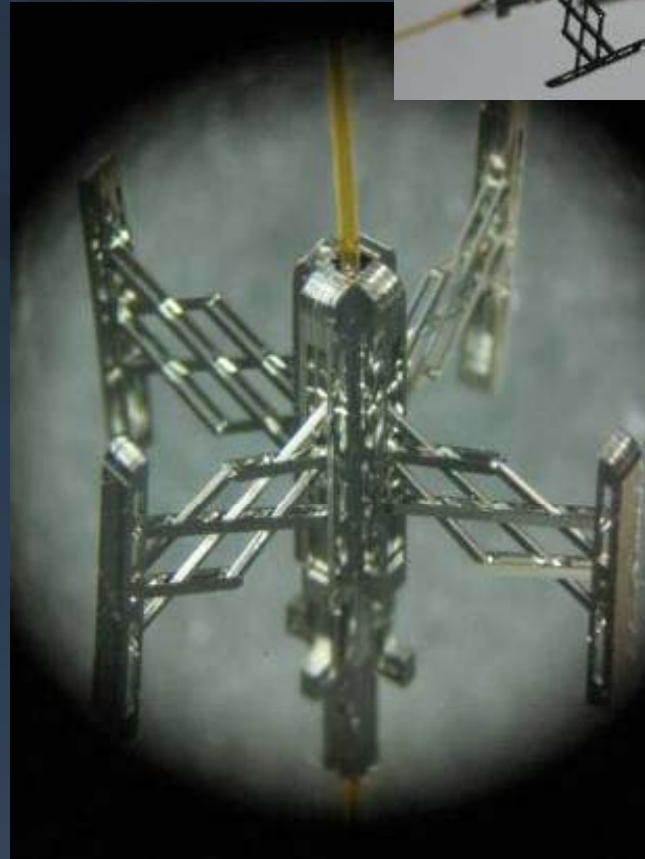
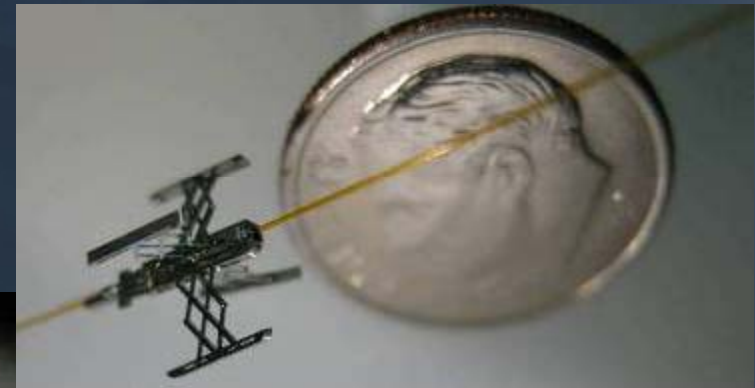

Example of capabilities

Miscellaneous

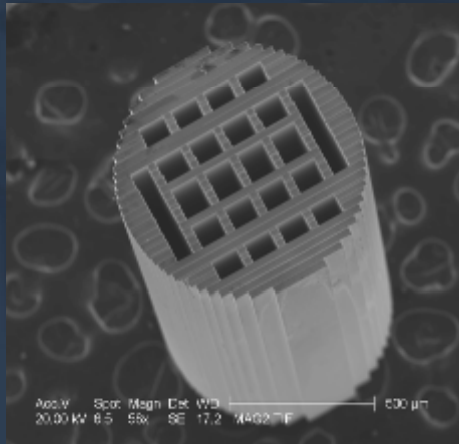

Multi-lumen metal tube

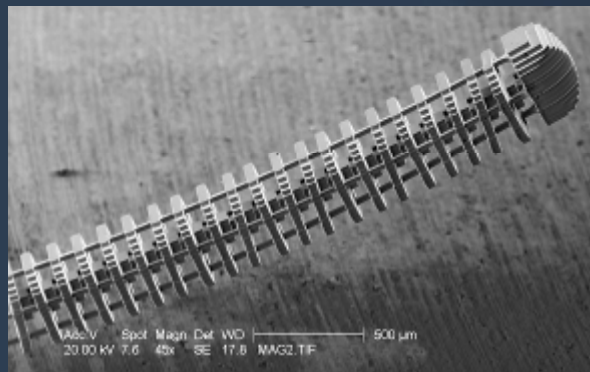
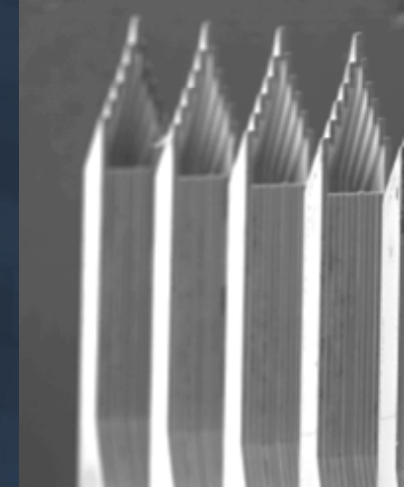
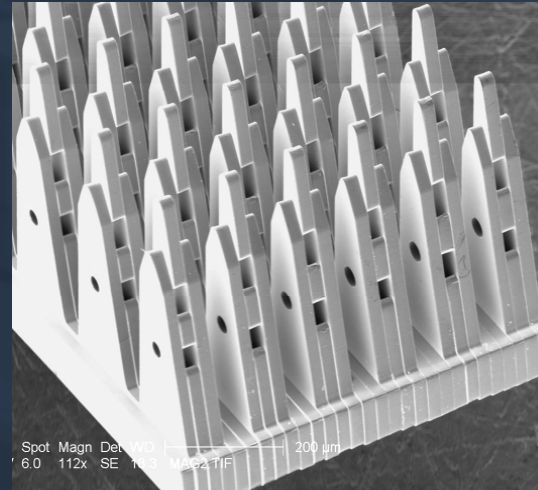

Omni-directional steerable guidewire (0.017" diameter)

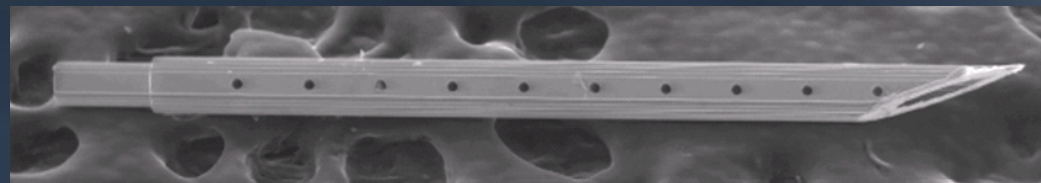

Microneedle array and 0.005" OD single microneedle

NIH BRP Project

- \$5.1M ‘Bioengineering Research Partnership’ (BRP) grant over 5 years
- Topic: “Steerable MEMS Instruments for Precise Intracardiac Surgery”
- Team
 - Boston University (P.I., steerable needle technology),
 - Microfabrica (MEMS instruments)
 - Harvard Medical School/Children’s Hospital (cardiac and fetal surgery)
- Goal: develop instruments and techniques for minimally invasive heart surgery for patients ranging from adult through fetus.
- Conditions targeted are
 - PFOs
 - Mitral valve regurgitation
 - Hypoplastic left heart syndrome
 - Aortic valve thickening
 - Etc.

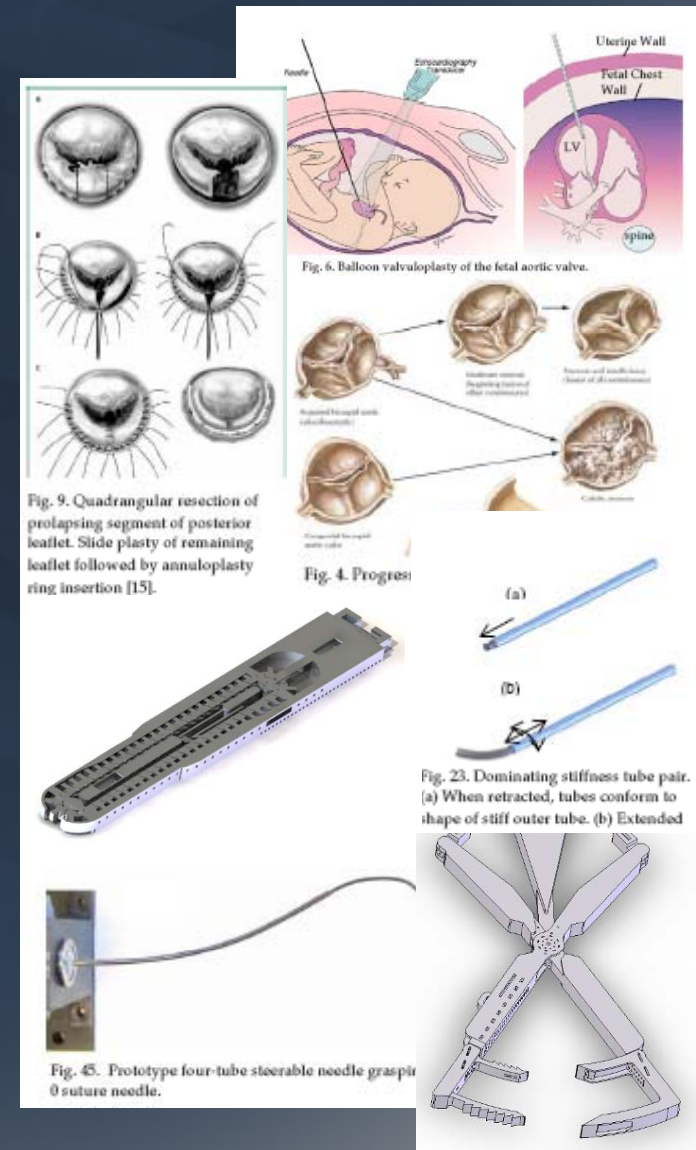

Tissue Removal “Shredder”

- Targeted at removal of subpulmonary muscle in the treatment of Tetralogy of Fallot, etc.
- Needs to work on endocardium and myocardium
- Cuts, transports proximally without vacuum
- Applications in other surgical areas

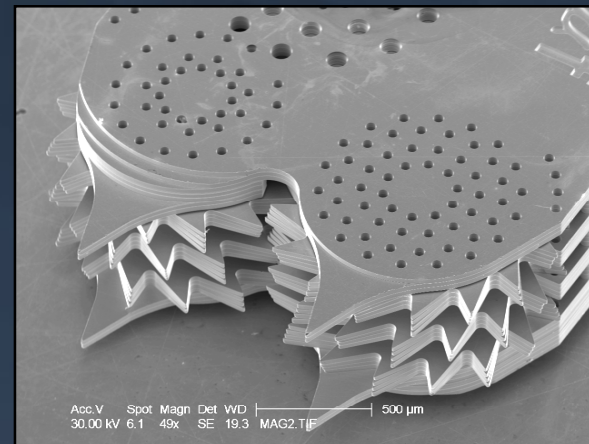
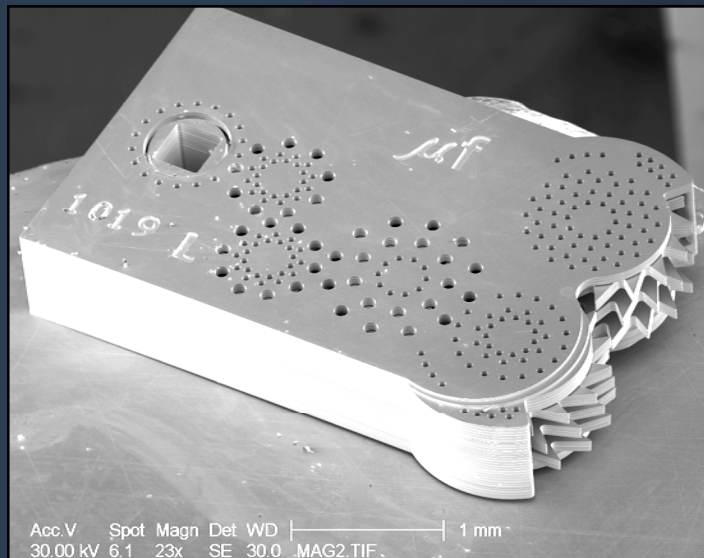
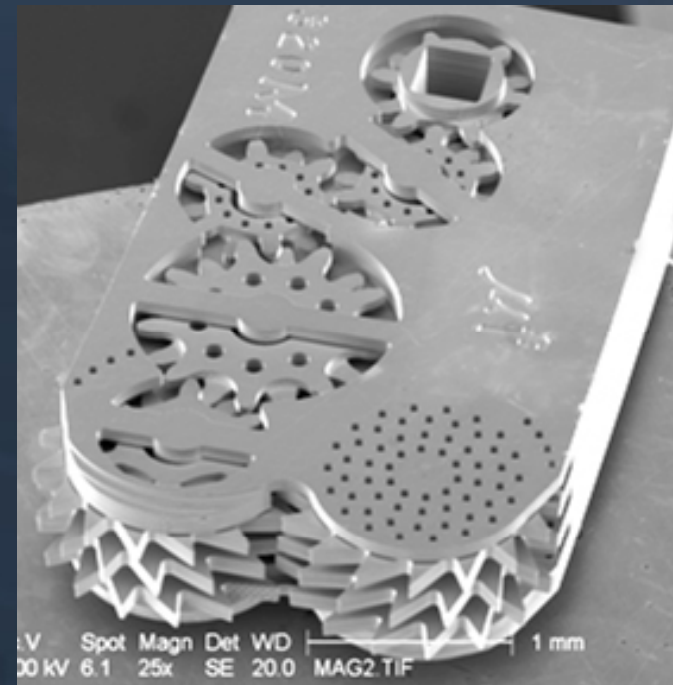

Tissue Approximation “MicroToggle”

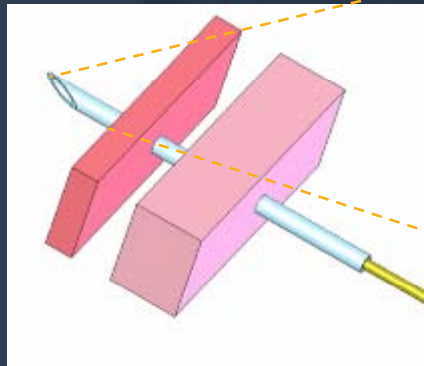

Step 1. Pierce tissue with cannula

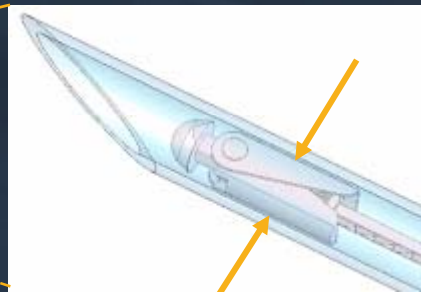

1 mm (folded)

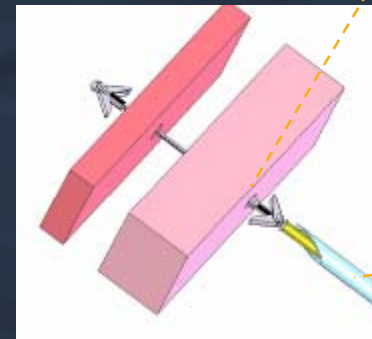

Step 2. Withdraw cannula

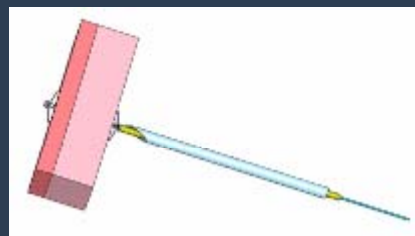
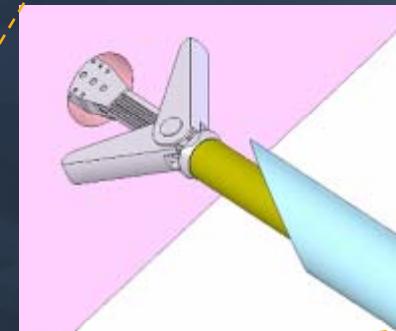

Step 3. Pull wire to approximate tissue

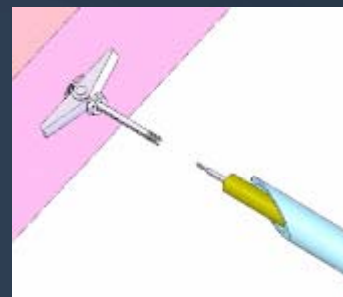

Step 4. Twist wire to release

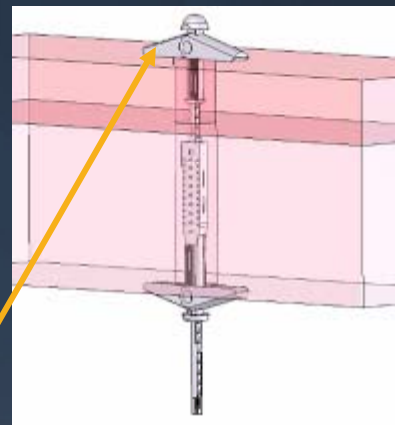

Final result

4 mm (expanded)



EFAB Design Flow

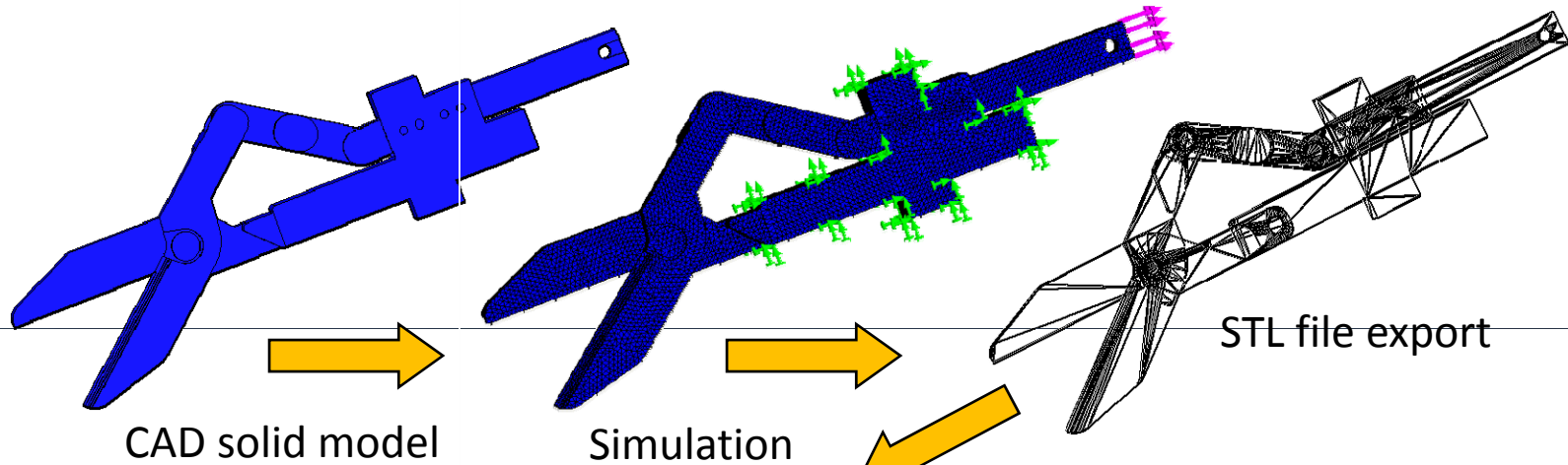

CAD solid model

Simulation

STL file export

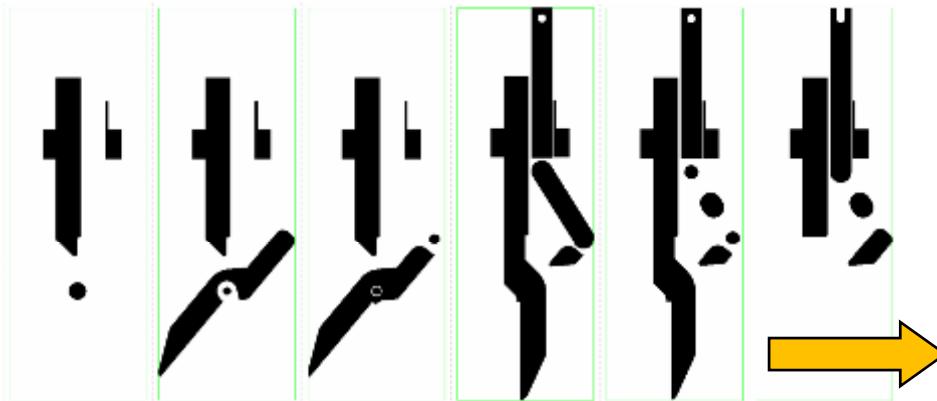

LayerView cross-sectioning

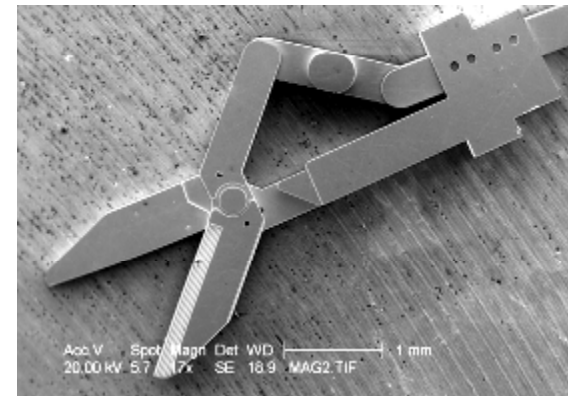

Fabricated device

Strength/Robustness

- Interlayer adhesion is very good (a large fraction of bulk strength)
- Examples
 - Multilayer boss broke without delamination
 - 1 mm diameter forceps survived >20 pounds tension
 - Milling cutter chucked in Mototool at ~6000 RPM easily milled acrylic



EFAB-Produced
Milling Cutter

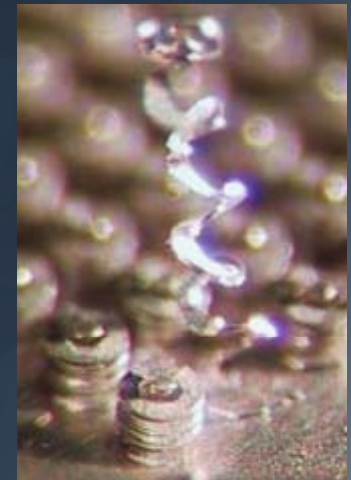

Typical EFAB Process Specs

Parameter	Value
Layer-to-layer registration	$\pm 1.5 \mu\text{m}^*$
Layer thickness tolerance	$\pm 2.0 \mu\text{m}$
X/Y tolerance	$\sim \pm 1.0 \mu\text{m}$
Maximum height	$\sim 3 \text{ mm}$ (1 mm to date)
Maximum length and width	Limited only by wafer size
Minimum X/Y feature size	$10\text{-}20 \mu\text{m}^{**}$
Layer thickness (can select for any layer)	$4\text{-}30 \mu\text{m}^{***}$
Maximum number of layers	TBD (50 to date)
Substrate	High-purity alumina (if required)
Surface finish of layer top/bottom	$0.15 \mu\text{m Ra}^{****}$

* Expect 2-3X improvement with equipment upgrades

** At present comparable to layer thickness, but high-aspect ratio process being developed

*** $50 \mu\text{m}$ under development; $100\text{-}200 \mu\text{m}$ possible

**** Optical quality surfaces can be provided if needed

EFAB Materials

Metal	Status
Valloy™-120	Commercial: Ni-Co alloy, primary EFAB structural material
Edura™-180	Commercial: Rhodium (inert platinum group metal), used selectively where extreme hardness/wear resistance needed
Nickel	Commercial
Nickel-titanium	Feasibility demonstrated
Titanium, titanium alloy	Under investigation
Palladium, palladium-cobalt	Under investigation
Cobalt-chromium	Under investigation

Note: Coatings may be used to improve biocompatibility

Valloy-120

- Electroplated, fully-dense, nickel-cobalt alloy with excellent mechanical properties
- Laser weldable

Mechanical property

Value

Yield strength	900 MPa (130,534 psi) or greater
Ultimate tensile strength	~1.1 GPa (159,542 psi)
Modulus of elasticity	180 Gpa (26,106,793 psi)
Fatigue life	Infinite @ < 400 MPa (58,015 psi) stress
Interlayer adhesion	~ 600 MPa (87,023 psi)
Hardness	>400 HV (~40 Rc)

Biocompatibility of Valloy-120

- Passed all biocompatibility tests for <24 hr exposure to tissue and circulating blood
- Also passed mutagenicity and subacute toxicity tests

Test

Cytotoxicity (ISO)
Systemic toxicity (USP, ISO)
Intracutaneous irritation (ISO)
Sensitization (ISO maximization)
Pyrogen (ISO)
Hemolysis (ASTM)
Partial thromboplastin time (ISO)
Platelet and leukocyte counts (ISO)
Ames mutagenicity (ISO)
Subacute intraperitoneal toxicity (ISO)
Corrosion (ASTM)
Purity (glow discharge mass spectrometry)....

Result

Excellent: 0 cytotoxicity score
Excellent: No evidence of systemic toxicity
Excellent: Negligible primary irritation index
Excellent: 0% sensitization response
Excellent: Non-pyrogenic
Excellent: Hemolytic index 0.4% (non-hemolytic)
Excellent: Non-activator of intrinsic coagulation pathway
Excellent: Equivalent to HDPE
Excellent: Non-mutagenic
Excellent: Negative for signs of systemic toxicity
Excellent: No signs of corrosion
High

EFAB Materials and Some Medical Materials Compared

	Valloy-120	Edura-180	Ti6Al4V, wrought, F1472	410 stainless, 650° temper	BioDur 316LS stainless, 52% cold-worked	Superelastic Ni-Ti
Ultimate tensile strength (MPa)	1100	TBD	930	834	1034	1070
Yield strength (MPa)	900	TBD	860	721	848	814
Hardness (Rc)	40	>68*	32-36	25	36	~33

* 1000 Hv: nearly ceramic-like

EFAB vs. Other Manufacturing Technologies

EFAB bridges the gap, enabling unique mm-scale devices with micron-precision features

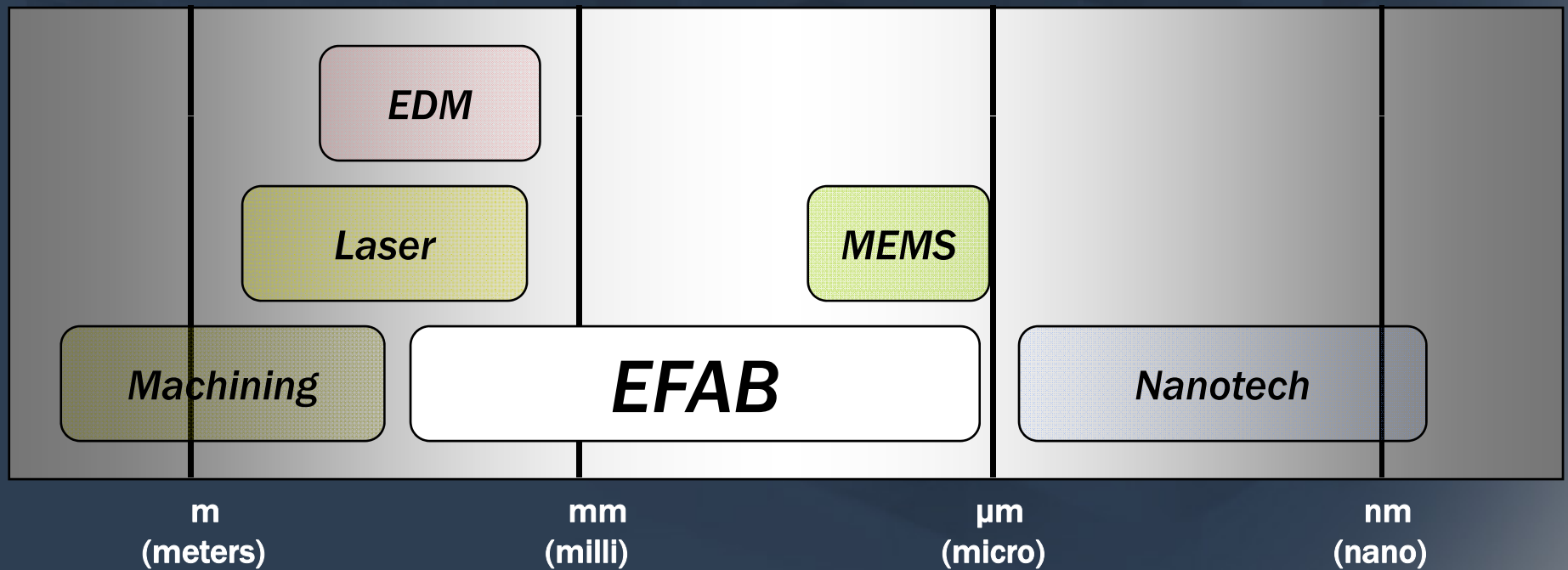

EFAB Compared with Conventional Metal Processes

- Compared with machining, metal injection molding, and electrical discharge machining, EFAB provides
 - Greater complexity
 - Mechanisms without assembly
 - Smaller features
 - Often, greater accuracy and lower cost
- Compared with laser or photochemical machining and stamping, EFAB provides
 - Far greater complexity
 - Mechanisms without assembly
 - Greater accuracy
 - Smaller features
 - Freedom from artifacts

EFAB Comparison Chart

	EFAB Technology	Milling, Turning, Grinding	Electrical Discharge Machining	Laser Machining	Metal Injection Molding	Photochemical Machining	Stamping, Fineblanking, Deep Drawing
Geometrical flexibility	Nearly arbitrary 3-D with internal and undercut features, curved channels, etc.	Limited 3-D (internal features difficult/impossible)	Limited 3-D (e.g., no undercuts)	Typically flat or tubular 2.5-D (extruded-type features)	Complex 3-D; limited internal & undercut features limited	Typically flat 2.5-D (extruded-type features)	Punched and bent shapes from thin sheet metal
Overall device size (mm)	Max: >1 (current), 2-3 (probable limit). Min: ~0.01	Max: unlimited. Min: sub-mm (e.g., 0.2-0.5)	Max: unlimited. Min: sub-mm	Max: 0.4-1 sheet thickness. Min: 0.3	Max: unlimited. Min: 50 mg weight	Max: unlimited. Min: ~0.003 sheet thickness	Max: unlimited. Min: 0.05 sheet thickness, 0.2 OD (deep drawing)
Minimum feature size (µm)	10-20 (X/Y, current) 5 (X/Y, future), 4 (Z)	30 (holes), 38 (walls), 50 (wire)	5 (holes)	15-20	250	75, usually ~sheet thickness	Usually ~sheet thickness, 13 (deep drawing)
Accuracy (+/- µm)	1-2	10-25 typical, 1.3-5 possible (milling and turning), 0.6 (grinding)	10-100	3-5	Typically 0.3-0.4% of nominal	5-13 µm or at least 10-30% of sheet thickness	50 (stamping), 10 (fineblanking), 5 (deep drawing)
Surface finish (µm)	0.15 Ra typical on horizontal surfaces, optical quality available	0.1-0.8 on some surfaces; often have tool marks	10-30 nm Rmax (micro-EDM)	0.5 Ra	0.8 rms	Not available. Scalping of sidewalls adds to roughness.	Limited by tool marks/dings/scratches, 0.3 rms (deep drawing)
Assemblies with multiple components and materials	Yes	No	No	No	No	No	No
Net shape processing	Yes in most cases	May need deburring, hardening	Yes in most cases	May need electropolishing, etc.	May need machining of tight tolerances, deburring for mold flash	Yes in most cases	May need deburring
Choice of materials	Depositible metals and metal alloys	Nearly unlimited	Most metals	Most metals	Stainless steel primarily	Chemically-etchable metals such as stainless, Ti, Ni-Ti	Many, but difficult with harder metals due to springback
Cost and lead time	Largely independent of complexity. Low for production; protos requires tooling. Typically weeks.	Strongly dependent on complexity. May be high for production, low for protos. Days-weeks.	Strongly dependent on complexity. Often high for production since slow; fairly low for protos. Days-weeks.	Dependent on complexity. May be high for production; low for protos. Days-weeks.	Very low for production; high for protos. Tooling cost strongly dependent of complexity. Weeks.	Largely independent of complexity. Low for production; low for protos. Days-weeks.	Low for production; high for protos. Tooling cost strongly dependent on complexity. Weeks.

EFAB vs. Si MEMS Fabrication Processes

- Pros
 - Complex, true 3-D shapes with dozens of layers (vs. 3-5)
 - Larger, more robust structures
 - Variety of metals (vs. silicon)
 - Ductile (vs. brittle) behavior
 - Higher strength
 - Far greater electrical and thermal conductivity
 - Higher temperature tolerance
 - Superior optical, magnetic properties
 - Rapid, intuitive design in 3-D (vs. time-consuming 2-D design)
- Cons
 - Dielectrics more difficult to process
 - Polycrystalline material
 - Single crystal material properties (e.g., low damping capacity) not available



Si MEMS device

EFAB vs. LIGA

- Pros
 - Complex, true 3-D shapes (vs. 2-D extrusions)
 - Wider range of materials (vs. electroplated metals only)
 - Higher aspect ratio (height : minimum feature size), and without a synchrotron
 - More uniform alloy composition
- Cons
 - Rougher sidewalls
 - Somewhat lower strength along Z

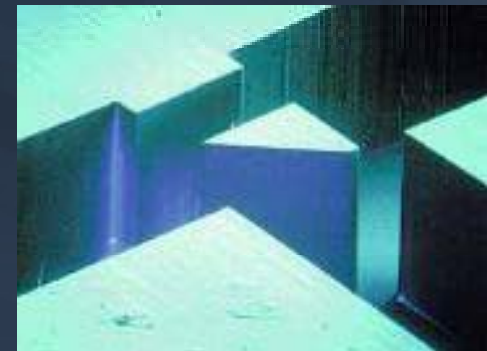

LIGA structure

Probing for Wafer Test

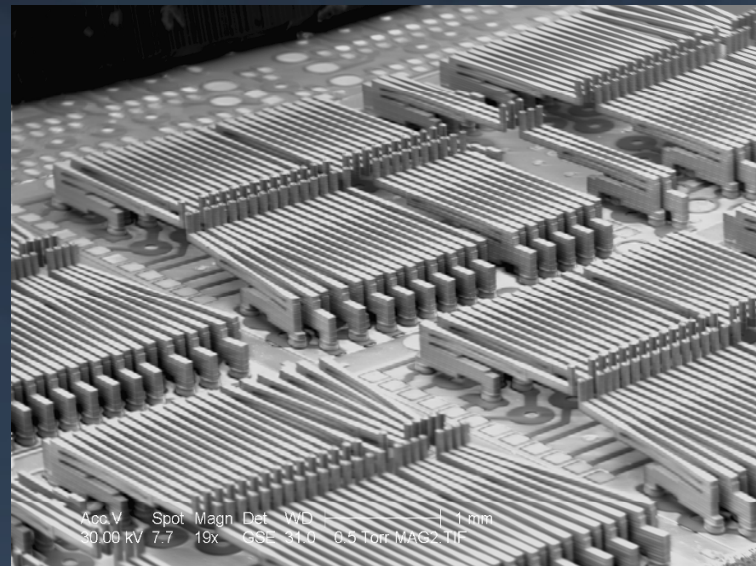
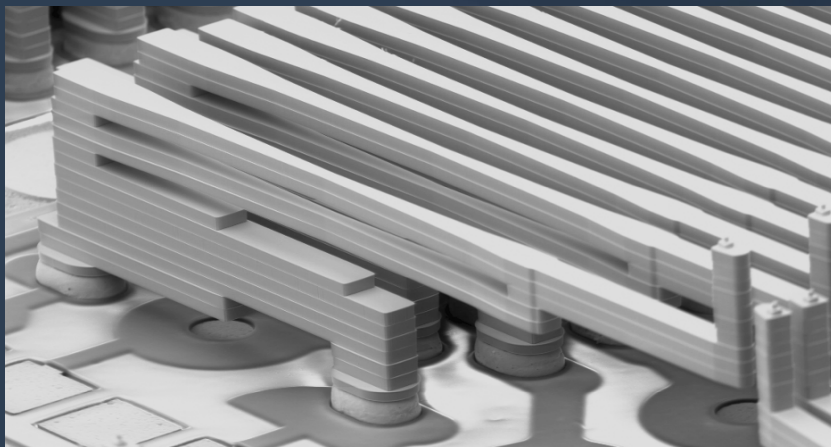
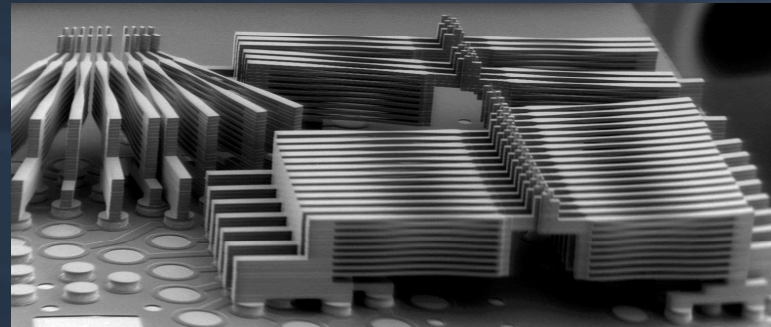
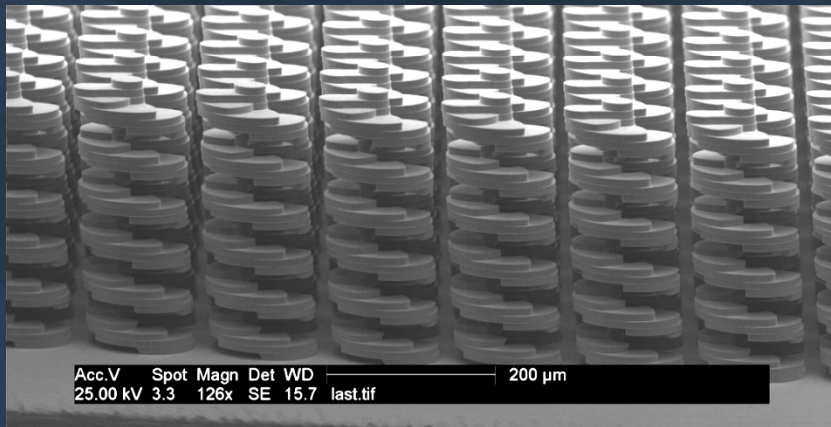

RF Devices Using EFAB

- Transmission Lines
- Antennas
 - Patch antennas
 - Phased array antenna
- RF Switches
- Filters
 - Fixed Filters
 - Tunable Filters
- Resonators
- Couplers
- Waveguides
- Duplexers
- Inductors
- Variable capacitors

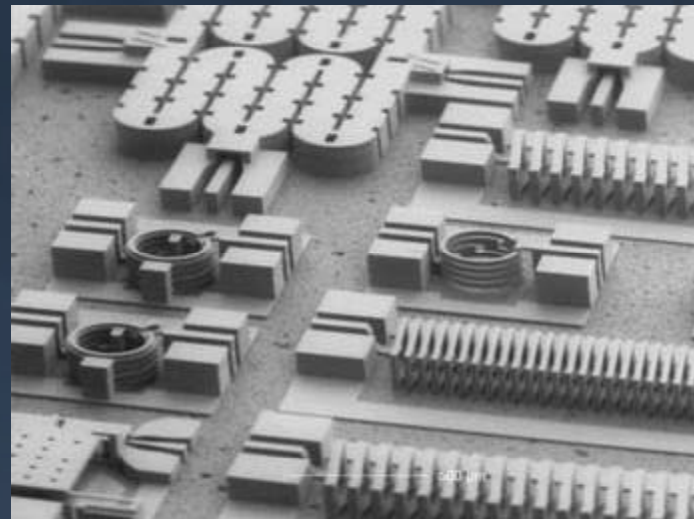
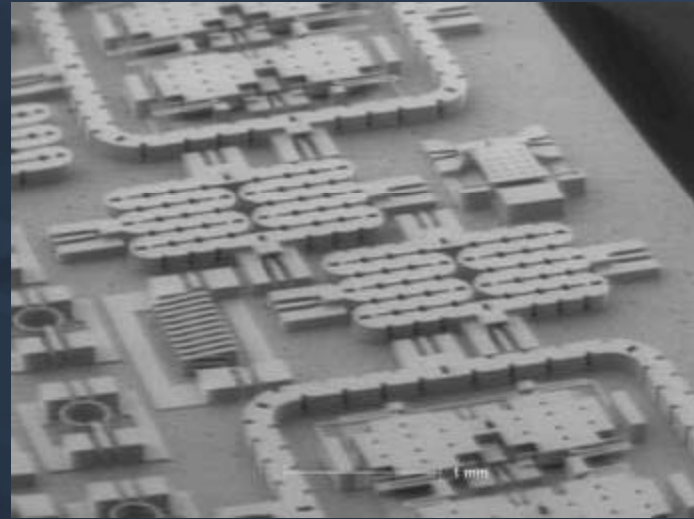

Microfabrica in a Nutshell

- Business** Design, development, and manufacturing of custom miniaturized mechanical components and devices
- Technology** EFAB®: unique production technology for manufacturing complex 3-D micro/mm-scale devices
- Markets**
- Medical
 - Semiconductor
 - Defense
- Corporate**
- Founded 1999
 - Venture-funded: >\$62M
 - 40,000 ft² facility in Van Nuys, CA (Los Angeles)

Microfabrica Design & Manufacturing Services

Customer-Designed Devices

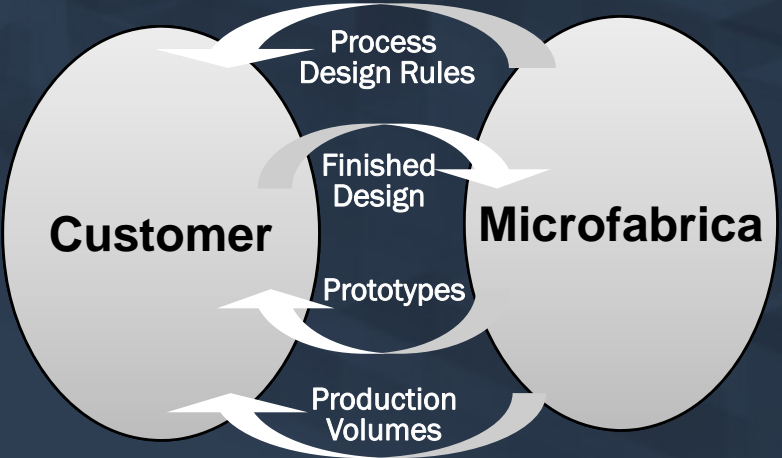

Turnkey

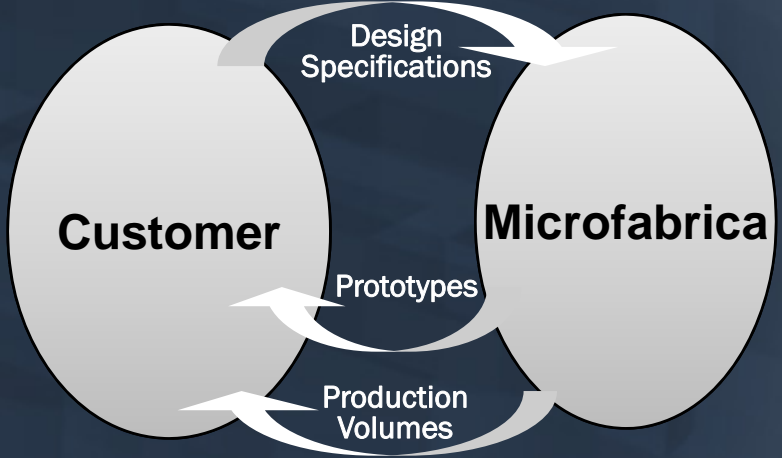

Collaborative Development

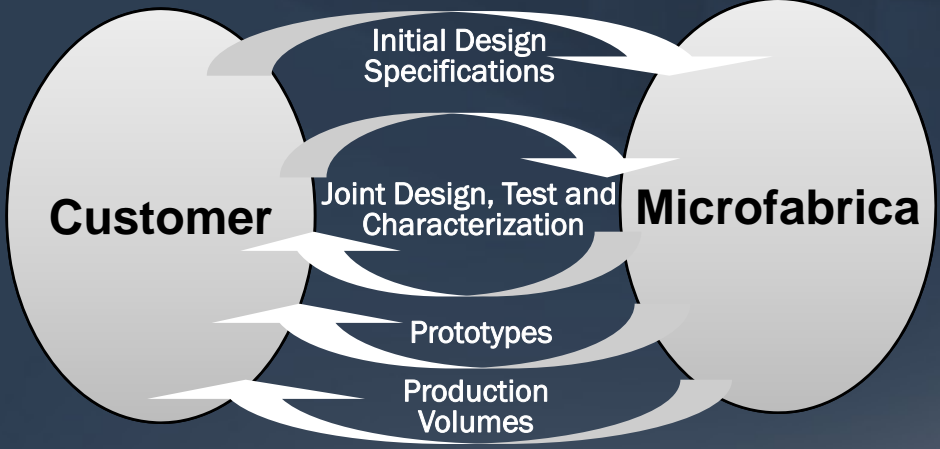

For More Information

Microfabrica Inc.
7911 Haskell Ave.
Van Nuys, CA 91406
www.microfabrica.com



EFAB[®] Technology:
Unlocking the Potential of Miniaturized Medical Devices

Adam L. Cohen
EVP, Technology and CTO, Microfabrica Inc.

Table of contents

Section	Page	Section	Page
Introduction	1	Special EFAB Capabilities	24
EFAB technology	2	Integrating EFAB Devices into Complete Products	25
How the Process Works	3	EFAB Limitations	25
Benefits of EFAB to the Medical Device Industry	5	Non-Medical EFAB Applications	26
EFAB Technology in Detail	7	Choosing and Using EFAB Technology	27
Manufacturing Process Comparisons	13	References	30
MEMS Processes	22	About the Author	31

Adam Cohen
EVP, Technology and CTO
818-786-3322